

COMFORT

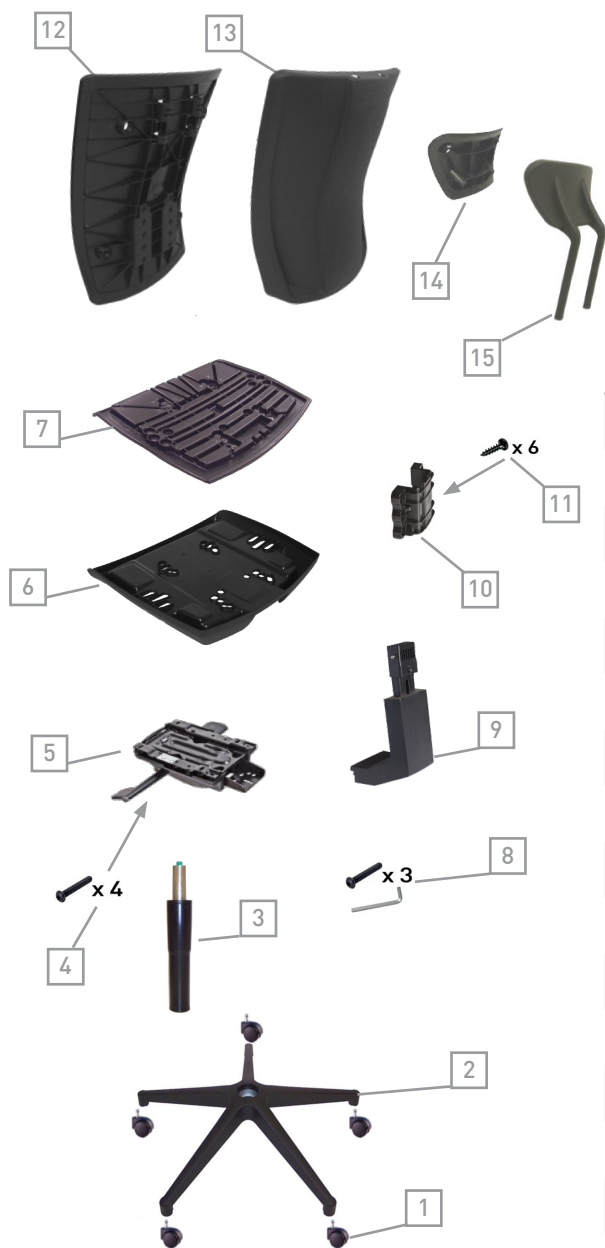

COMFORT with headrest

Sincro/Synchro



Codice/Code	Descrizione/Description
1. RBL010201	Ruota Base Libera Ø50, perno Ø11, nera Base castor Ø50, push fit stem Ø11, black
2. B070201	Base B07 Ø700mm, perno Ø11mm, nera Base B07 Ø700mm, stem Ø11mm, black
3. P0901	Pompa a gas H.220/132, conifica H.100, nera Gas column H.220/132, lower gas cone H.100, black
4. 0609	Viti TBEI M6 x 30 T.Ø13 (con blocca filetto), brunite Screws BHCS M6 x 30 H.Ø13 (with thread lock), burnished
5. PP0501	Meccanismo sincro, 4 posizioni, nero Synchro mechanism, 4 positions, black
6. SS0701	Sottosedile art. 07 nero Outer seat art. 07 black
7. SD071801FE	Sedile interno art. 07 a 18 borchie e con barre in ferro, nero Inner seat art. 07 with 18 nuts and inner steel bars, black
8. KIT14097	Kit viti M8 x 30 TBEI, brunite + Chiave esagonale Screw kit M8 x 30 IHHEC, burnished + Hexagon key
9. SH4001LSY	Reggischienale art. 40 Up & Down, nero Backrest support art. 40 Up & Down, black
10. SSCH0201	Componente per fissaggio reggischienale 15/16/20/21 Component for fixing backrest support 15/16/20/21
11. 0578	Viti combinate autofilettanti M6 x 19 T.Ø13, zincate Tapping screws (Philips/slotted) M6 x 19 H.Ø13, zinc
12. SCI1601	Schienale interno art. 16, nero Inner backrest art. 16, black
13. SCE1601CF	Coprischienale art. 16 con fori x poggiatesta, nero Outer backrest art. 16 with hole for headrest, black
14. PGT10101	Pannello per poggiatesta art. 01, nero Headrest pannell art. 01, black
15. PGTE0101	Poggiatesta art. 01, nero Headrest art. 01, black

*Accessori/Optional:

16. B230218	Base B23 in alluminio lucido Ø700mm, perno Ø11mm Polished aluminium base B23 Ø700mm, stem Ø11mm
17. P0918	Pompa a gas H.220/132, conifica H.75, cromata Gas column H.220/132, lower gas cone H.75, chromed
18. RBL020201	Ruota Base libera gommata Ø50, perno Ø11, nera Base soft castor Ø50, push fit stem Ø11, black
19. BR26DX-SX01	Bracciolo regolabile art. 26., destro+sinistro nero Adjustable armrest art. 26, right+left, black
20. KIT13008	Kit viti M6 x 36 TBEI, brunite + Chiave esagonale per fissaggio braccioli Screw kit M6 x 36 IHHEC, burnished + Hexagon key for armrest fixing
21. SS1201	Sottosedile art. 12, nero Outer seat art. 12, black
22. PP0501TRS	Meccanismo 05 sincro con traslatore, 4 posizioni, nero Synchro mechanism 05 with seat slider, 4 positions, black
23. GMSDI07	Cuscino sedile in PU schiumato a freddo D.65 SP.35mm PU cold foamed cushion for inner seat D.65 TH.35mm

N.B.: altri braccioli e meccanismi sincro a scelta nel catalogo generale

N.B.: other armrests and synchro mechanisms are available on our general catalogue



COMFORT with headrest

Back System



Codice/Code	Descrizione/Description
1. RBL010201	Ruota Base Libera Ø50, perno Ø11, nera Base castor Ø50, push fit stem Ø11, black
2. B070201	Base B07 Ø700mm, perno Ø11mm, nera Base B07 Ø700mm, stem Ø11mm, black
3. P0901	Pompa a gas H.220/132, conifica H.100, nera Gas column H.220/132, lower gas cone H.100, black
4. 0609	Viti TBEI M6 x 30 T.Ø13 (con blocca filetto), brunite Screws BHCS M6 x 30 H.Ø13 (with thread lock), burnished
5. PP2301	Contatto permanente a 2 leve con sistema Up & Down integrato, nero Permanent contact with 2 levers and integrated Up & Down system, black
6. SS0701	Sottosedile art. 07 nero Outer seat art. 07 black
7. SD071801FE	Sedile interno art. 07 a 18 borchie e con barre in ferro, nero Inner seat art. 07 with 18 nuts and inner steel bars, black
8. SF2501	Soffietto art.25 PP23/22/03 95x330mm, nero Bellows art.25 PP23/22/03 95x330mm, black
9. TSH22	Supporto "T" corto per PP22-PP23-PP29 Support "T" short for PP22-PP23-PP29
10. 0578	Viti combinate autofilettanti M6 x 19 T.Ø13, zincate Tapping screws (Philips/slotted) M6 x 19 H.Ø13, zinc
11. SCI1601	Schienale interno art. 16, nero Inner backrest art. 16, black
12. SCE1601CF	Coprischienale art. 16 con fori x poggiatesta, nero Outer backrest art. 16 with hole for headrest, black
13. PGTI0101	Pannello per poggiatesta art. 01, nero Headrest pannell art. 01, black
14. PGTE0101	Poggiatesta art. 01, nero Headrest art. 01, black

*Accessori/Optional:

15. B230218	Base B23 in alluminio lucido Ø700mm, perno Ø11mm Polished aluminium base B23 Ø700mm, stem Ø11mm
16. P0918	Pompa a gas H.220/132, conifica H.75, cromata Gas column H.220/132, lower gas cone H.75, chromed
17. RBL020201	Ruota Base libera gommata Ø50, perno Ø11, nera Base soft castor Ø50, push fit stem Ø11, black
18. BR26DX-SX01	Bracciolo regolabile art. 26,, destro+sinistro nero Adjustable armrest art. 26, right+left, black
19. KIT13008	Kit viti M6 x 36 TBEI, brunite + Chiave esagonale per fissaggio braccioli Screw kit M6 x 36 IHHEC, burnished + Hexagon key for armrest fixing
20. SS1201	Sottosedile art. 12, nero Outer seat art. 12, black
21. PP2901	A-Sincro 29 con 3 leve e meccanismo Up & Down, nero A-Synchro 29 with 3 handles and Up & Down mechanism, black
22. GMSDI07	Cuscino sedile in PU schiumato a freddo D.65 SP.35mm PU cold foamed cushion for inner seat D.65 TH.35mm

N.B.: altri braccioli a scelta nel catalogo generale

N.B.: other armrests are available on our general catalogue



COMFORT

Sincro/Synchro



Codice/Code	Descrizione/Description
1. RBL010201	Ruota Base Libera Ø50, perno Ø11, nera Base castor Ø50, push fit stem Ø11, black
2. B070201	Base B07 Ø700mm, perno Ø11mm, nera Base B07 Ø700mm, stem Ø11mm, black
3. P0901	Pompa a gas H.220/132, conifica H.100, nera Gas column H.220/132, lower gas cone H.100, black
4. 0609	Viti TBEI M6 x 30 T.Ø13 (con blocca filetto), brunite Screws BHCS M6 x 30 H.Ø13 (with thread lock), burnished
5. PP0501	Meccanismo sincro, 4 posizioni, nero Synchro mechanism, 4 positions, black
6. SS0701	Sottosedile art. 07 nero Outer seat art. 07 black
7. SD071801FE	Sedile interno art. 07 a 18 borchie e con barre in ferro, nero Inner seat art. 07 with 18 nuts and inner steel bars, black
8. KIT14097	Kit viti M8 x 30 TBEI, brunite + Chiave esagonale Screw kit M8 x 30 IHHEC, burnished + Hexagon key
9. SH4001LSY	Reggischienale art. 40 Up & Down, nero Backrest support art. 40 Up & Down, black
10. SSCH0201	Componente per fissaggio reggischienale 15/16/20/21 Component for fixing backrest support 15/16/20/21
11. 0578	Viti combinate autofilettanti M6 x 19 T.Ø13, zincate Tapping screws (Philips/slotted) M6 x 19 H.Ø13, zinc
12. SCI1601	Schienale interno art. 16, nero Inner backrest art. 16, black
13. SCE1601	Coprischienale art. 16, nero Outer backrest art. 16, black

*Accessori/Optional:

14. B230218	Base B23 in alluminio lucido Ø700mm, perno Ø11mm Polished aluminium base B23 Ø700mm, stem Ø11mm
15. P0918	Pompa a gas H.220/132, conifica H.75, cromata Gas column H.220/132, lower gas cone H.75, chromed
16. RBL020201	Ruota Base libera gommata Ø50, perno Ø11, nera Base soft castor Ø50, push fit stem Ø11, black
17. BR26DX-SX01	Bracciolo regolabile art. 26, destro+sinistro nero Adjustable armrest art. 26, right+left, black
18. KIT13008	Kit viti M6 x 36 TBEI, brunite + Chiave esagonale per fissaggio braccioli Screw kit M6 x 36 IHHEC, burnished + Hexagon key for armrest fixing
19. SS1201	Sottosedile art. 12, nero Outer seat art. 12, black
20. PP0501TRS	Meccanismo 05 sincro con traslatore, 4 posizioni, nero Synchro mechanism 05 with seat slider, 4 positions, black
21. GMSDI07	Cuscino sedile in PU schiumato a freddo D.65 SP.35mm PU cold foamed cushion for inner seat D.65 TH.35mm

N.B.: altri braccioli e meccanismi sincro a scelta nel catalogo generale

N.B.: other armrests and synchro mechanisms are available on our general catalogue



COMFORT

Back System

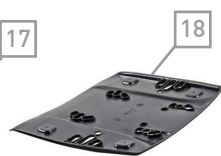
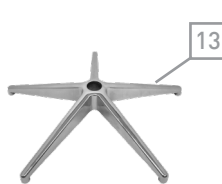
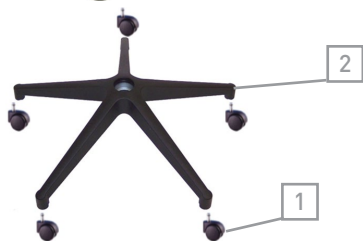
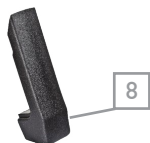
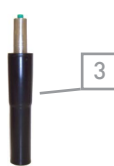
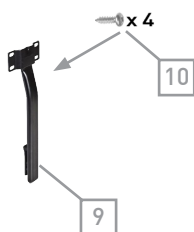

Codice/Code	Descrizione/Description
1. RBL010201	Ruota Base Libera Ø50, perno Ø11, nera Base castor Ø50, push fit stem Ø11, black
2. B070201	Base B07 Ø700mm, perno Ø11mm, nera Base B07 Ø700mm, stem Ø11mm, black
3. P0901	Pompa a gas H.220/132, conifica H.100, nera Gas column H.220/132, lower gas cone H.100, black
4. 0609	Viti TBEI M6 x 30 T.Ø13 (con blocca filetto), brunito Screws BHCS M6 x 30 H.Ø13 (with thread lock), burnished
5. PP2301	Contatto permanente a 2 leve con sistema Up & Down integrato, nero Permanent contact with 2 levers and integrated Up & Down system, black
6. SS0701	Sottosedile art. 07 nero Outer seat art. 07 black
7. SD071801FE	Sedile interno art. 07 a 18 borchie e con barre in ferro, nero Inner seat art. 07 with 18 nuts and inner steel bars, black
8. SF2501	Soffietto art.25 PP23/22/03 95x330mm, nero Bellows art.25 PP23/22/03 95x330mm, black
9. TSH22	Supporto "T" corto per PP22-PP23-PP29 Support "T" short for PP22-PP23-PP29
10. 0578	Viti combinate autofilettanti M6 x 19 T.Ø13, zincate Tapping screws (Philips/slotted) M6 x 19 H.Ø13, zinc
11. SCI1601	Schienale interno art. 16, nero Inner backrest art. 16, black
12. SCE1601	Coprischienale art. 16, nero Outer backrest art. 16, black

*Accessori/Optional:

13. B230218	Base B23 in alluminio lucido Ø700mm, perno Ø11mm Polished aluminium base B23 Ø700mm, stem Ø11mm
14. P0918	Pompa a gas H.220/132, conifica H.75, cromata Gas column H.220/132, lower gas cone H.75, chromed
15. RBL020201	Ruota Base libera gommata Ø50, perno Ø11, nera Base soft castor Ø50, push fit stem Ø11, black
16. BR26DX-SX01	Bracciolo regolabile art. 26,, destro+sinistro nero Adjustable armrest art. 26, right+left, black
17. KIT13008	Kit viti M6 x 36 TBEI, brunito + Chiave esagonale per fissaggio braccioli Screw kit M6 x 36 IHHEC, burnished + Hexagon key for armrest fixing
18. SS1201	Sottosedile art. 12, nero Outer seat art. 12, black
19. PP2901	A-Sincro 29 con 3 leve e meccanismo Up & Down, nero A-Synchro 29 with 3 handles and Up & Down mechanism, black
20. GMSDI07	Cuscino sedile in PU schiumato a freddo D.65 SP.35mm PU cold foamed cushion for inner seat D.65 TH.35mm

N.B.: altri braccioli a scelta nel catalogo generale

N.B.: other armrests are available on our general catalogue

COMFORT

Fusto 4 gambe/4 Legs frame

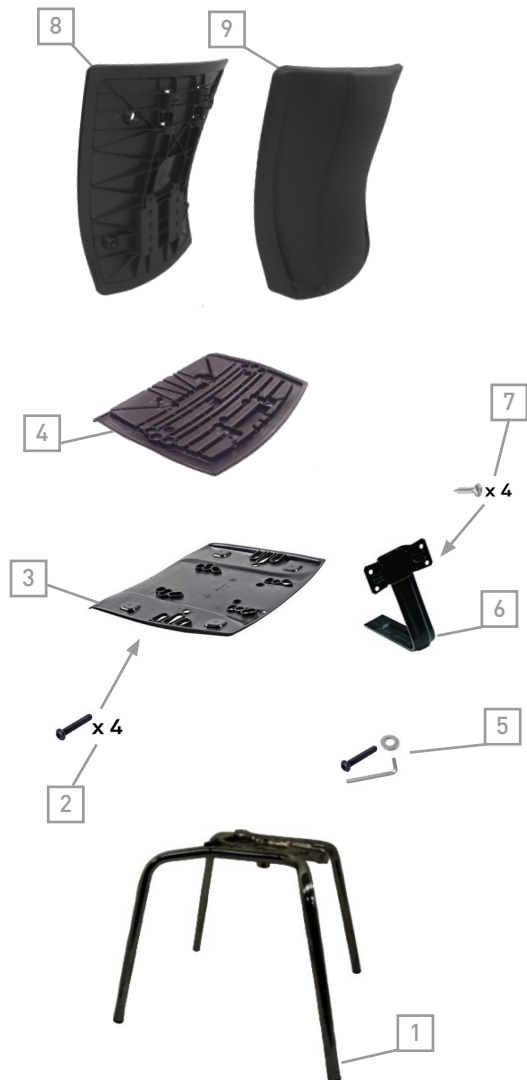

Codice/Code	Descrizione/Description
1. F4G01	Fusto 4 gambe, nero 4 legs frame, black
2. 0609	Viti TBEI M6 x 30 T.Ø13 (con blocca filetto), brunite Screws BHCS M6 x 30 H.Ø13 (with thread lock), burnished
3. SS1201	Sottosedile art. 12 nero Outer seat art. 12 black
4. SD071801FE	Sedile interno art. 07 a 18 borchie e con barre in ferro, nero Inner seat art. 07 with 18 nuts and inner steel bars, black
5. KIT15014	Kit vite M8 x 25 TBEI + Rondella Ø8 x 24 zincata + Chiave esagoale Screw kit M8 x 25 IHHEC + Washer Ø8 x 24 zinc + Hexagon key
6. LM1101	Lama reggischienale a "T" art.11, nero Backrest support "T" shape art.11, black
7. 0578	Viti combinate autofilettanti M6 x 19 T.Ø13, zincate Tapping screws (Philips/slotted) M6 x 19 H.Ø13, zinc
8. SCI1601	Schienale interno art. 16, nero Inner backrest art. 16, black
9. SCE1601	Coprischienale art. 16, nero Outer backrest art. 16, black
*Accessori/Optional:	
10. F4G18	Fusto 4 gambe cromato Chromed 4 legs frame
11. BR25DX-SX01	Bracciolo fisso art. 25,, destro+sinistro nero Fixed armrest art. 25, right+left black
12. KIT13008	Kit viti M6 x 36 TBEI, brunita + Chiave esagonale per fissaggio braccioli Screw kit M6 x 36 IHHEC, burnished + Hexagon key for armrest fixing

N.B.: altri braccioli a scelta nel catalogo generale

N.B: other armrests are available on our general catalogue



COMFORT

Slitta/Cantilever

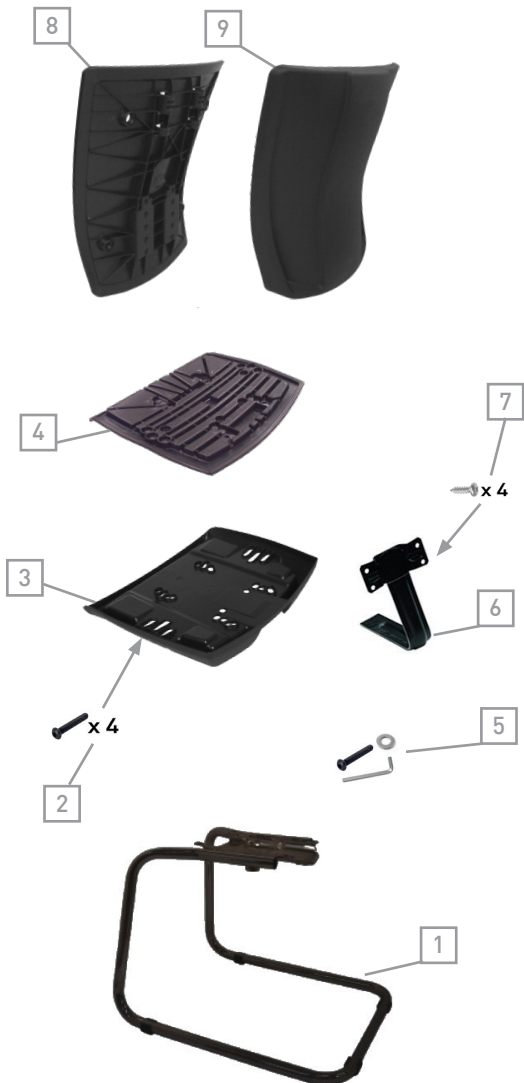

Codice/Code	Descrizione/Description
1. GS0101	Slitta sedia, nera Cantilever, black
2. 0609	Viti TBEI M6 x 30 T.Ø13 (con blocca filetto), brunite Screws BHCS M6 x 30 H.Ø13 (with thread lock), burnished
3. SS0701	Sottosedile art. 07 nero Outer seat art. 07 black
4. SD071801FE	Sedile interno art. 07 a 18 borchie e con barre in ferro, nero Inner seat art. 07 with 18 nuts and inner steel bars, black
5. KIT15014	Kit vite M8 x 25 TBEI + Rondella Ø8 x 24 zincata + Chiave esagoale Screw kit M8 x 25 IHHEC + Washer Ø8 x 24 zinc + Hexagon key
6. LM1101	Lama reggischienale a "T" art.11, nero Backrest support "T" shape art.11, black
7. 0578	Viti combinate autofilettanti M6 x 19 T.Ø13, zincate Tapping screws (Philips/slotted) M6 x 19 H.Ø13, zinc
8. SCI1601	Schienale interno art. 16, nero Inner backrest art. 16, black
9. SCE1601	Coprischienale art. 16, nero Outer backrest art. 16, black

***Accessori/Optional:**

10. GS0118	Slitta sedia, cromata Chromed cantilever
11. BR25DX-SX01	Bracciolo fisso art. 25,, destro+sinistro nero Fixed armrest art. 25, right+left black
12. KIT13008	Kit viti M6 x 36 TBEI, brunite + Chiave esagonale per fissaggio braccioli Screw kit M6 x 36 IHHEC, burnished + Hexagon key for armrest fixing

N.B.: altri braccioli a scelta nel catalogo generale

N.B: other armrests are available on our general catalogue

